

ANCILLARY ITEMS (IF REQUIRED)

CLOSURE PLATE

TYPE	X (mm)	Gauge (mm)	Length (mm)	No.
P1	150	0.9	3000	-
P2	200	1.2	3000	10
P3	250	1.2	3000	-
P4	300	2.0	3000	-

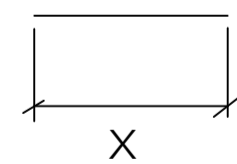

ANGLE FLASHING

TYPE	X (mm)	Y (mm)	Gauge (mm)	Length (mm)	No.
X1	150	50	0.9	3000	2

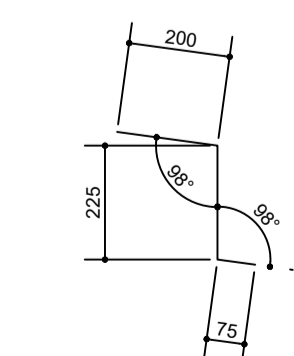
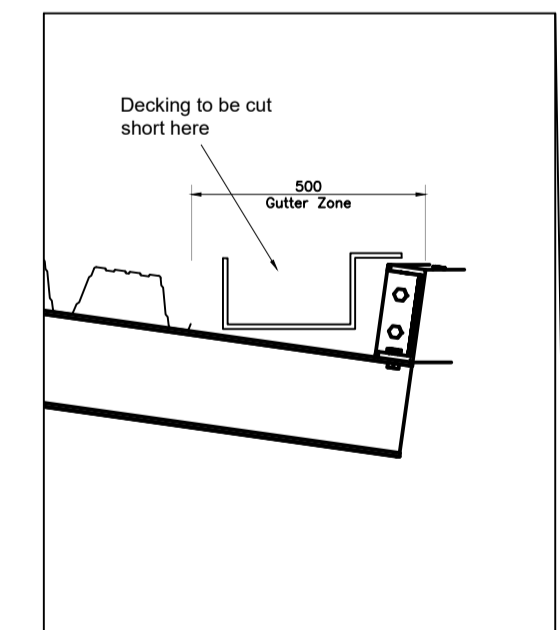
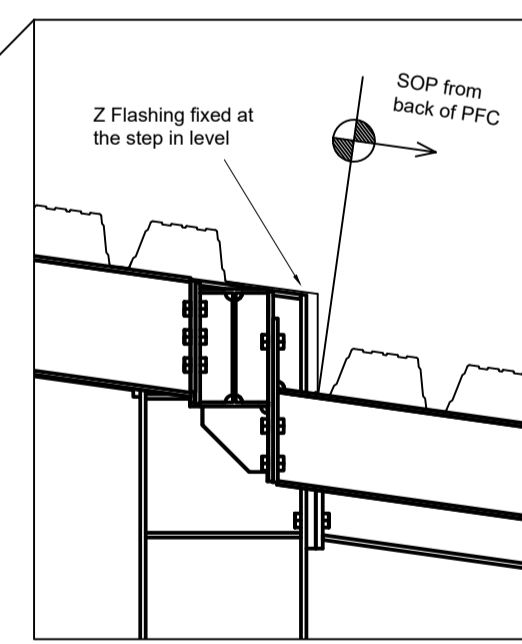
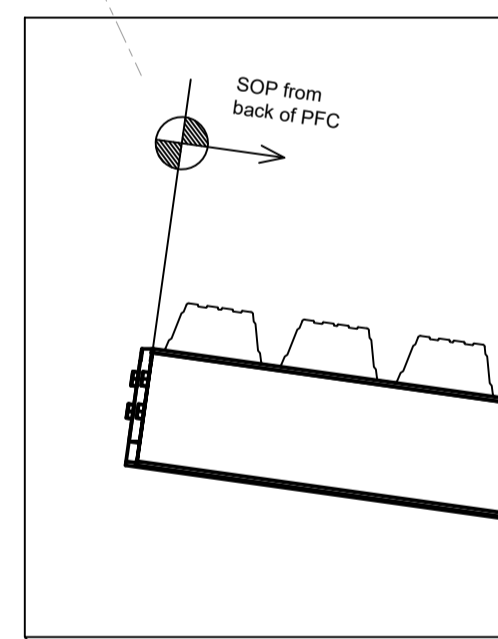
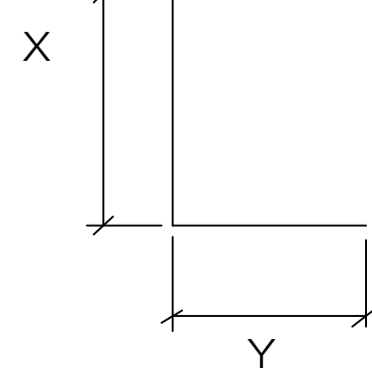

Z1 Flashing  
4.5m lengths - 1.6mm gauge  
15no. lengths

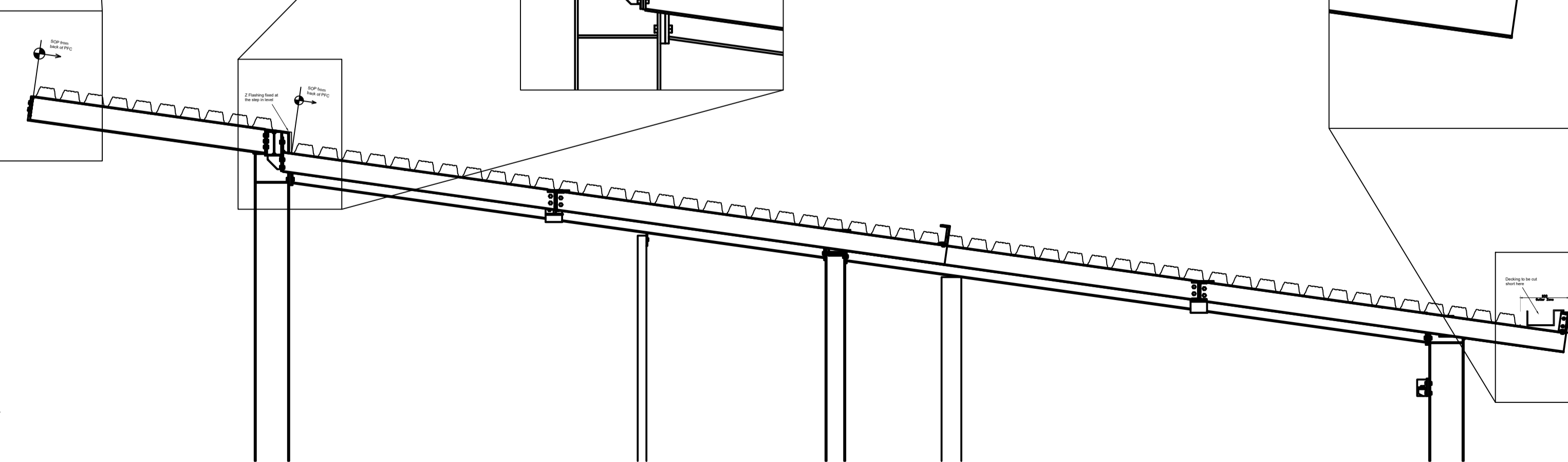

Elevation on GL 2